

## Services Related to Booth Operation

---

### 05-1 Transport Service

---

05-1-1 Transport, Load-in and Load-out Services

---

### 05-2 Rental Fixtures

---

05-2-1 Package Booth Service & Rental Fixtures

---

05-2-2 PC Rental

---

05-2-3 Catering Service for Booths

---

### 05-3 Infrastructure Services

---

05-3-1 Internet Connection

---

05-3-2 Temporary Telephone Line Service

---

05-3-3 Antenna Installation

---

### 05-4 Booth Management Services

---

05-4-1 Hotel Reservations

---

05-4-2 Food / Beverage Tickets

---

05-4-3 Lunch Box Delivery Service

---

05-4-4 Receptionist / Interpreter

---

05-4-5 Booth Photography

---

05-4-6 Booth Cleaning

---

05

## Transport, Load-in and Load-out Services

### ■ Transport within Japan

Exhibitors requiring cargo collection services on-site and single-lot, small package delivery are requested to submit "Application for Transport within Japan" to Ishikawa-Gumi, Ltd. by Friday, October 7.

When you applied for single-lot, small package delivery service, please clearly indicate "Attention to Inter BEE 2011" together with the exhibitor's name, hall number and booth number on address labels and cargo receipts, and send a package(s) with address labels to Ishikawa-Gumi by Friday, October 28.

"Small packages" are packages with maximum exterior dimensions (W + D + H) of 120cm and a maximum weight of 15kg.

Inter BEE 2011	
Booth Number	1 2 3 4
Exhibitors Name	○○○○Ltd.
Person in Charge	Mr. Taro Yamada

Courier services are available at the Courier Service Center, located in the north conference room in Exhibition Hall 6.

### ■ Load-in / Load-out Services

Exhibitors requiring loading / unloading services on the show site, such as unloading exhibits from trucks, delivering them to exhibition booths, unpacking and re-packing, removal from the exhibition booth, and loading onto trucks must fill in the "Application for Load-in / Load-out Services" and submit it to Ishikawa-Gumi, Ltd. by Friday, October 7.

Operation and forklift charges:

	Fee (Without tax)
Worker / person	¥4,725 / hour
2.5-ton forklift	¥15,750 / 30 min.
5.0-ton forklift	Estimated based on contents of loading
Crane	Estimated based on contents of loading

# Package Booth Service & Rental Fixtures

Three types of package booth are available as described below. Exhibitors who require package booth and / or rental fixtures must fill in the "Application for Booth Display & Rental Fixtures" and submit it to Mruyama Inc. by Friday, October 14.

## Package Booth

Please choose one of the following booth types:

### 1-Booth Package

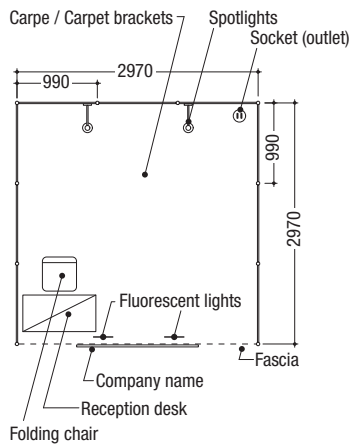
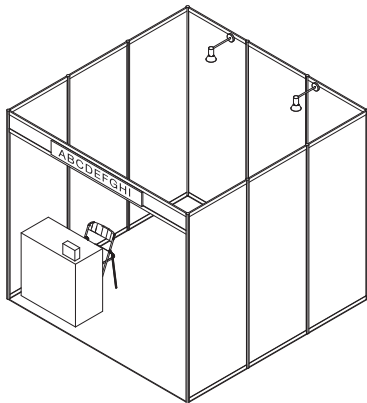

No.	item	Quantity
21	Carpet	1 Booth
22	Carpet brackets	3m
4	Fascia	3m
29	Reception desk	1
36	Folding chair	1
	Company name display	1
57	Spotlights	2
58	Fluorescent light	2
59	Socket (outlet)	1

(including tax) **¥73,500**

### 2-Booth Package

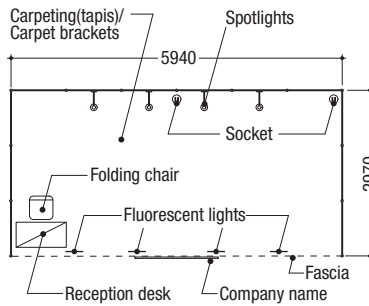
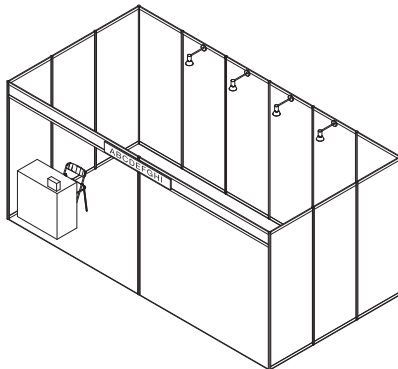

No.	item	Quantity
21	Carpet	2 Booth
22	Carpet brackets	6m
4	Fascia	6m
29	Reception desk	1
36	Folding chair	1
	Company name display	1
57	Spotlights	4
58	Fluorescent light	4
59	Socket (outlet)	2

(including tax) **¥115,500**

### 3-Booth Package

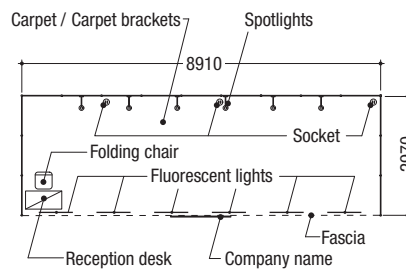
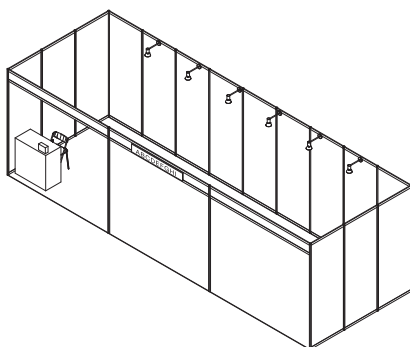

No.	item	Quantity
21	Carpet	3 Booth
22	Carpet brackets	9m
4	Fascia	9m
29	Reception desk	1
36	Folding chair	1
	Company name display	1
57	Spotlights	6
58	Fluorescent light	6
59	Socket (outlet)	3

(including tax) **¥157,500**

※ For exhibitors whose booths are located at the corner. If the booth is located at the corner, wall panels facing the aisle will not be installed and only a fascia will be set up. Company name display will be placed on the front side of the fascia. Exhibitors who require to set up wall panel, are required to contact the Management Office. (No additional cost is required)

## Package Booth Service & Rental Fixtures

### ■ Original Booth

Original booth designs are assembled on each exhibitor's selection of standard and specially arranged parts. These sketches are design samples provided for reference purposes. Different designs are also available in the same budget range. For more details on booth design and order placement, please contact Murayama Inc.



Package Booth Service & Rental Fixtures

**Rental Fixtures**

Package booths may be installed with additional components according to each exhibitor's selection of items from the following list of Rental Fixtures / Furniture.

(Prices include consumption tax.)

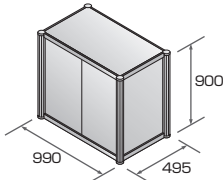
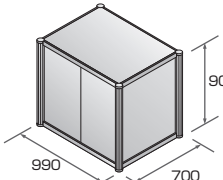
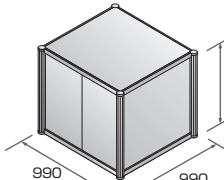
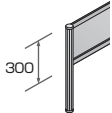
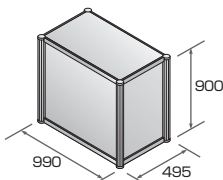
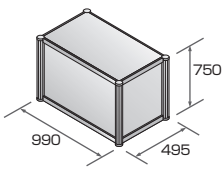
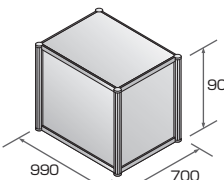
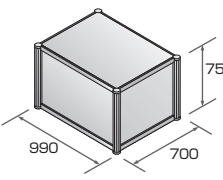
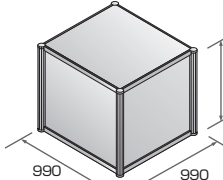
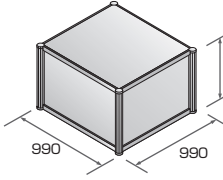
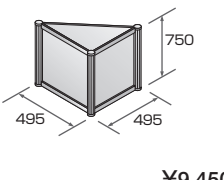
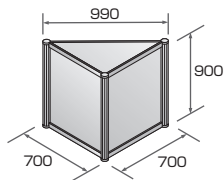
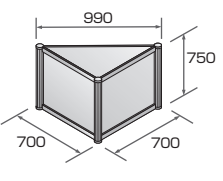
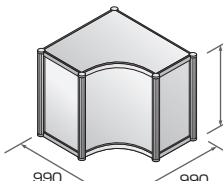
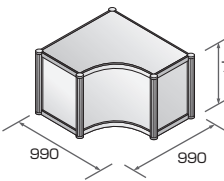
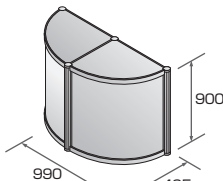
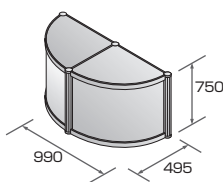
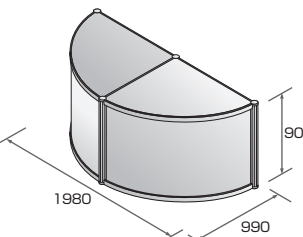
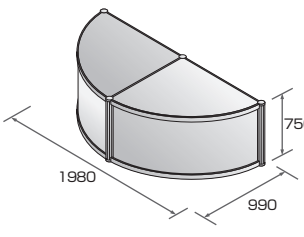
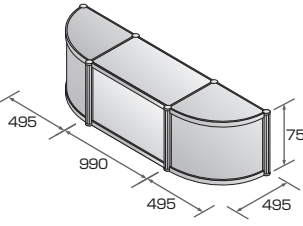
<p>1 Display counter (with storage space)</p>  <p>¥21,000</p>	<p>2 Display counter (with storage space)</p>  <p>¥23,100</p>	<p>3 Display counter (with storage space)</p>  <p>¥26,250</p>	<p>4 Fascia</p>  <p>1m ¥4,200</p>
<p>5 Display counter</p>  <p>¥15,750</p>	<p>6 Display counter</p>  <p>¥13,650</p>	<p>7 Display counter</p>  <p>¥17,850</p>	<p>8 Display counter</p>  <p>¥15,750</p>
<p>9 Display counter</p>  <p>¥21,000</p>	<p>10 Display counter</p>  <p>¥21,000</p>	<p>11 Display counter</p>  <p>¥9,450</p>	<p>12 Display counter</p>  <p>¥15,750</p>
<p>13 Display counter</p>  <p>¥13,650</p>	<p>14 Display counter</p>  <p>¥26,250</p>	<p>15 Display counter</p>  <p>¥24,150</p>	<p>16 Display counter</p>  <p>¥34,650</p>
<p>17 Display counter</p>  <p>¥29,400</p>	<p>18 Display counter</p>  <p>¥36,750</p>	<p>19 Display counter</p>  <p>¥34,650</p>	<p>20 Display counter</p>  <p>¥36,750</p>

Package Booth Service & Rental Fixtures

Rental Fixtures

Package booths may be installed with additional components according to each exhibitor's selection of items from the following list of Rental Fixtures / Furniture.

(Prices include consumption tax.)

<p>21 Floor carpet</p> <p>For samples of the floor carpet and wall color, refer to the manual, Section 05-2-1.7.</p> <p style="text-align: right;">¥18,900 / booth</p>	<p>22 Wall panel color</p> <p>For samples of the floor carpet and wall color, refer to the manual, Section 05-2-1.7.</p> <p style="text-align: right;">¥2,100 / m<sup>2</sup></p>	<p>23 Brackets for carpeting</p>  <p style="text-align: right;">¥630 / m</p>	<p>24 Wall panel</p>  <p style="text-align: right;">¥10,500</p>
<p>25 Wall partition</p>  <p style="text-align: right;">¥6,300</p>	<p>26 Door with lock</p>  <p style="text-align: right;">¥29,400</p>	<p>27 Accordion door</p>  <p style="text-align: right;">¥24,150</p>	<p>28 Shelf</p>  <p style="text-align: right;">¥5,250</p>
<p>29 Reception desk</p>  <p>W900×D450×H800</p> <p style="text-align: right;">¥8,400</p>	<p>30 Cut out lettering</p> <p>H50 ¥1,155 / letter H90 ¥1,365 / letter H150 ¥2,100 / letter H200 ¥2,310 / letter H300 ¥3,360 / letter</p>  <p>The above prices are for the specified fonts. The prices for your logos and / or special fonts are available on your request.</p>	<p>31 Explanatory panel</p> <p>*The price will vary according to the volume and the specifications of manuscripts.</p> <p>W1,200×H900 (300 letter) ¥52,500 ~ W900×H600 (250 letter) ¥42,000 ~ W600×H500 (150 letter) ¥36,750 ~</p>	<p>32 Reception set</p>  <p style="text-align: right;">¥15,225</p>
<p>33 Meeting set</p>  <p style="text-align: right;">¥28,560</p>	<p>34 System counter</p>  <p>W600×D600×H1,020</p> <p style="text-align: right;">¥12,600</p>	<p>35 Potted plants</p>  <p>Large: ¥3,675 Medium: ¥2,625 Small: ¥1,260 Flower: ¥1,050</p>	<p>36 Folding chair</p>  <p style="text-align: right;">¥630</p>
<p>37 Meeting set</p>  <p style="text-align: right;">¥25,200</p>	<p>38 Counter chairs</p>  <p>A:H500 B:H600 C:H700</p> <p style="text-align: right;">¥3,150/each</p>	<p>39 Counter chairs</p>  <p>A:H500 B:H600 C:H700</p> <p style="text-align: right;">¥3,675/each</p>	<p>40 Tables</p>  <p>A:W1800×D600×H730 B:W1500×D600×H730 C:W1200×D600×H730</p> <p style="text-align: right;">¥3,675/each</p>



Package Booth Service & Rental Fixtures

■ Rental Fixtures

Package booths may be installed with additional components according to each exhibitor's selection of items from the following list of Rental Fixtures / Furniture.

(Prices include consumption tax.)

<p>41 Table / white top</p>  <p>A:W800×D450×H600    ¥2,100                  B:W600×D600×H600    ¥3,150                  C:750×H600    ¥4,200</p>	<p>42 Unit counter</p>  <p>A:W1200×D600×H800    ¥12,600                  B:W1500×D600×H800    ¥13,650</p>	<p>43 Island counter</p>  <p>External size:W1500×D600×H920                  Internal size:W1450×D530×H290                  with light &amp; lock    ¥25,200</p>	<p>44 PC chair</p>  <p>¥4,200</p>
<p>45 Stacking chair</p>  <p>A:Blue                  B:White                  C:Silver    ¥3,150</p>	<p>46 Sign stand</p>  <p>The angle is free.                  ¥4,200</p>	<p>47 Rack</p>  <p>W900×D450×H1800    ¥6,825</p>	<p>48 Display Stand</p>  <p>W1090×D400×H1180    ¥12,600</p>
<p>49 Fire extinguisher</p>  <p>¥42,00</p>	<p>50 Refrigerator</p>  <p>*Size (m/m) :    ¥2,1000                  A Large: 170 ℓ    ¥18,900                  B Medium: 100~106 ℓ    ¥15,750                  C Small: 70~74 ℓ</p>	<p>51 Catalogue stand</p>  <p>A:¥5,775    B:¥1,575</p>	<p>52 Coffee maker</p>  <p>200 cups    ¥31,500</p>
<p>53 White cloth</p>  <p>H1000×W2000    ¥1,575 / sheet</p>	<p>54 Business card holder</p>  <p>¥1,575</p>	<p>55 Arm spotlight</p>  <p>100W reflecting bulb    ¥3,675</p>	<p>56 Spotlight</p>  <p>100W beam-type bulb    ¥3,675</p>
<p>57 Fluorescent light</p>  <p>40W    ¥3,675</p>	<p>58 Power socket 100V(E)</p>  <p>2-way outlet w/o earthing    ¥3,150                  2-way outlet w/ earthing    ¥3,675</p>	<p>59 Halogen spotlight</p>  <p>Halogen bulb 300W    ¥7,350</p>	<p></p>

※ For details on panel attachment parts, please contact the contractor directly.

Package Booth Service & Rental Fixtures

■ Rental Fixtures

Package booths may be installed with additional components according to each exhibitor's selection of items from the following list of Rental Fixtures / Furniture.

(Prices include consumption tax.)

<p>60 20.1" LCD Flat Screen Display</p>  <p>●External dimensions: W450×H438×D228mm</p> <p>¥ 46,200</p>	<p>61 26" LCD Flat Screen Display</p>  <p>●External dimensions: W682×H565×D266mm</p> <p>¥ 61,950</p>
<p>62 30" LCD Flat Screen Display</p>  <p>●External dimensions: W1000×H602×D304mm</p> <p>¥ 110,250</p>	<p>63 32" LCD Flat Screen Display</p>  <p>●External dimensions: W786×H606×D297mm</p> <p>¥ 110,250</p>
<p>64 37" LCD Flat Screen Display</p>  <p>●External dimensions: W904×H596×D87mm</p> <p>¥ 117,600</p>	<p>65 40" LCD Flat Screen Display</p>  <p>●External dimensions: W1055.4×H608.6×D140mm</p> <p>¥ 123,900</p>
<p>66 52" LCD Flat Screen Display</p>  <p>●External dimensions: W1572×H923×D126mm</p> <p>¥ 165,900</p>	<p>67 LCD Television Stand</p>  <p>¥ 9,450</p>
<p>68 DVD Player</p>  <p>●External dimensions: W420×H55×D283mm</p> <p>¥ 12,600</p>	<p>69 P.A. System</p>  <p>Mixer / amp, 2 speakers, wired microphone</p> <p>¥ 34,125</p>

※ Murayama Inc. Offers a wide variety of projectors and screens to meet your specific needs.





# Package Booth Service & Rental Fixtures

## ■ Color samples







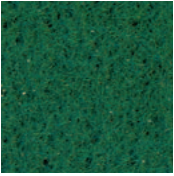
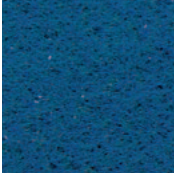
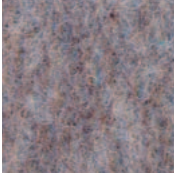
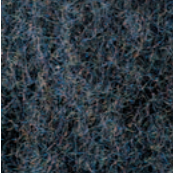

Carpet colors

※For those exhibitors who have applied for the package plan, the carpet will be included for FREE.

※For exhibitors who have applied for standard booth only, the carpet will be chargeable.

Red(731) 	Orange(702) 	Green(705) 
Blue(712) 	Gray(720) 	Black(606) 

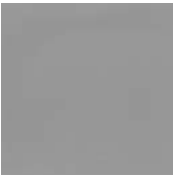
Wall colors (Chargeable)

1.Yellow (YG80-14) 	2.Red (YG80-18) 	3.Green (YG80-24) 	4.Skyblue (YG80-26) 
5.Blue (YG80-31) 	6.Navy (YG80-37) 	7.Gray (YG80-3) 	8.Black (YG80-7) 

# Package Booth Service & Rental Fixtures

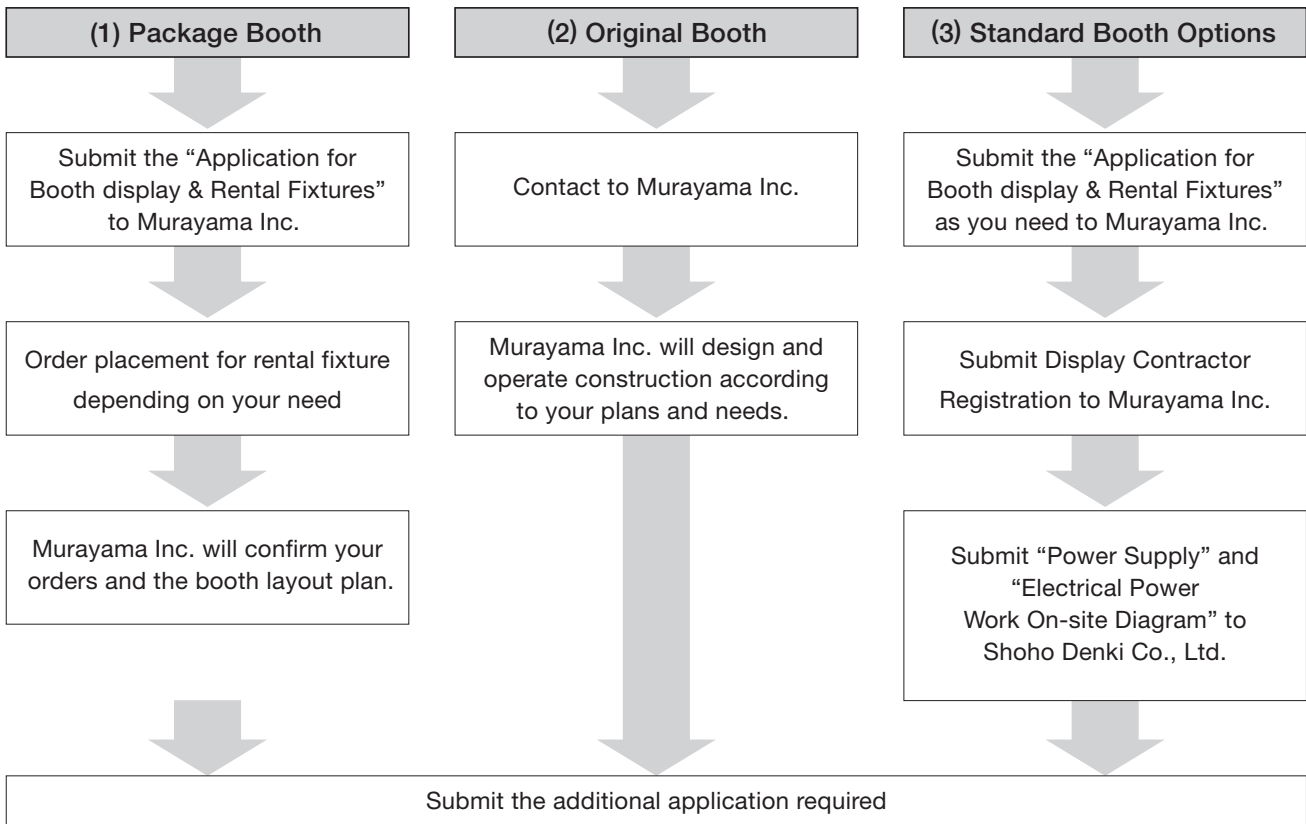

**Note:**

Exhibitors applying for the package booth are not required to submit the “Application for Power Supply the Electrical Power Work On-site Diagram” or the “Display Contractor Registration”. The package booth plan does not include costs related to electrical work or electric consumption charges.

Exhibitors who require PC rental service, are requested to submit the "Application for PC Rental" to Kissei Comtec by Friday, October 28. Due to a rush of applications for PC rentals immediately before the exhibition, we may not be able to meet all requests. Please submit your application as early as possible.

**Dates:**

Delivery: 10:00 a.m. – on Tuesday, November 15.

Pick-up: 5:00 p.m. – 7:00 p.m. on Friday, November 18 .

Separate fee estimates will be provided for exhibitors requiring a rental PC(s) delivery at a time other than that specified above.(Contact Kissei Comtec for further details.)

**Rental Fees**

Packing / unpacking fees and on-site work fees are not included in the list.

The list shows only part of the stock available. Exhibitors should contact Kissei Comtec directly to enquire about items not on the list, such as other PCs, expansion cards, peripherals and networking equipment. The price list below includes consumption tax. Prices in the list below are set especially for this exhibition. (Delivery / pickup on-site fees included)

Packing / unpacking fees and on-site work fees are not included.

**Inter BEE 2011 Rental Price List**

① Package Plan (PC rental with popular software installation and Windows Update)

No.	Presentation Plan	Price	OS	
P1	Toshiba dynabook TECRA M10 (English)	11,025	Vista-Business or WinXP(SP2)	Microsoft Office Standard Edition is installed. Presentation tool, "PowerPoint" is available. Please choose from 2000, XP, 2003, 2007 and 2010.
P2	DELL OptiPlex 980SFF(English) ※Display is not included.	12,075	Windows7 or WinXP(SP3)	
No.	Internet connection Plan	Price	OS	
P3	Toshiba dynabook TECRA M10 (English)	11,025	Vista-Business or WinXP(SP2)	Norton AntiVirus and the latest version of the Windows update software are installed for the security countermeasure.
P4	DELL OptiPlex 980SFF(English) ※Display is not included.	11,550	Windows7 or WinXP(SP3)	
No.	All in One Plan	Price	OS	
P5	Toshiba dynabook TECRA M10 (English)	14,700	Vista-Business or WinXP(SP2)	Microsoft Office Standard Edition, Norton AntiVirus and the latest version of the Windows update software are installed. Please choose from 2000, XP, 2003, 2007 and 2010.
P6	DELL OptiPlex 980SFF(English) ※Display is not included.	15,750	Windows7 or WinXP(SP3)	

② Laptop PC

(Price:Yen)

No.	Items	Price	RAM	CPU	VRAM	Drive	OS
1	DELL Latitude E6510 (English) (1600×900)	11,550	4096	Core i7 2.66G		DVDSuperMulti	Windows7 or WinXP(SP3)
2	DELL Latitude D520 (1024×768)	7,350	2048	Core2Duo2G		DVD±RW	Vista Business or WinXP(SP2)
3	Lenovo ThinkPad T510 4314-3VJ (1600×900)	11,025	2048	Corei5 2.40G		DVDSuperMulti	Windows7 Pro or WinXP(SP3)
4	Lenovo ThinkPad T410 2518-DAJ (1440×900)	10,500	2048	Corei5 2.40G		DVDSuperMulti	Windows7 Pro or WinXP(SP3)
5	Lenovo ThinkPad T61 7662-B2I (1440×900)	9,450	1024	Core2Duo 2.2G	Quadro NVS 140M	DVDSuperMulti	Vista Business or WinXP(SP2)
6	Toshiba dynabook Satellite K45 (1366×768)	8,925	2048	Core i7 2.66G		DVDSuperMulti	Windows7 or WinXP(SP3)
7	Toshiba dynabook Satellite K33 (1280×800)	8,400	2048	Core2Duo 2.8G		DVDSuperMulti	Windows7 or WinXP(SP3)
8	Toshiba dynabook TECRA M10 (English) (1280×800)	8,400	3072	Core2Duo 2.4G		DVD + CD	Vista-Business or WinXP(SP2)
9	Toshiba dynabook Satellite K30 226E/W (1280×800)	8,400	1024	Core2Duo 2.26G		DVDSuperMulti	Vista Business or WinXP
10	Apple MacBook Pro MC026J/A (1440×900)	12,075	4096	Core2Duo 2.66G	NVIDIA GeForce 9600M GT	DVDSuperMulti	OS X (10.5.6)
11	Expansion Memory 1024MB	525					
12	Expansion Memory 2048MB	735					
13	Security cable	420					

③ Desktop PC

(Price:Yen)

No.	Items	Price	RAM	CPU	VRAM	Drive	OS
14	HP dx7500 SF/CT	8,400	4096	Core2Duo 3.33G		DVD SuperMulti	Windows7 or WinXP(SP3)
15	HP dc7800 MT GV808PA#ABJ	8,400	1024	Core2Duo3G	RADEON X1600XT 256MB	DVD SuperMulti	WinXP(SP2)
16	DELL Optiplex 980SFF	9,450	4096	Corei7-860 2.8G	Radeon HD 3450 256MB	DVD±RW	Windows7 or WinXP(SP3)
17	DELL OptiPlex 980SFF(English)	9,450	4096	Corei7-860 2.8G	Radeon HD 3450 256MB	DVD SuperMulti	Windows7 or WinXP(SP3)
18	DELL OptiPlex 780SFF	8,400	4096	Core2Duo 3.33G		DVD SuperMulti	Windows7 or WinXP(SP3)
19	Apple MacPro MA356J/A	28,350	8GB	DCXeon 2.66G*2	Nvidia GeForce 7300GT	Super Drive	OS X (10.4) or OS X (10.5)
20	Expansion Memory 1024MB	525					
21	Expansion Memory 2048MB	735					

④ Useware

No.	Items	Price	Reference
22	Windows Update	2,100	Important update only
23	Network wiring work, setting up ect.	Ask	Network construction work in your booth
24	Establishment, setting-up etc.	Ask	
25	Installation fee for store sale and free application software	2,100~	

⑤ Software Rental (Microsoft Office and others)

No.	Items	Price	Reference
26	MS Office2010/2007/2003/XP/2000 Professional Plus	2,625	Japanese/English (for Windows only) , installation fee is Necessary
27	MS Office2010/2007/2003/XP/2000 Standard	2,100	Japanese/English (for Windows only) , installation fee is Necessary
28	Canon IT Solutions Nod32 AntiVirus	Free	Japanese/English (for Windows only) , installation fee is Necessary
29	Symantec EndpointProtection	525	Japanese/English (for Windows, MacOS) , installation fee is Necessary
30	Software installation fee per unit	2,100	Necessary

⑥ LCD Monitor

(Price:Yen)

No.	Items	Price	Reference
31	24"TFT Mitsubishi MDT241WG and others	14,700	WUXGA 24"(1920×1200)
32	23.6"TFT Samsung 2494HS and others	6,825	FHD 23,6"(1920×1080)
33	20"TFT Samsung 204B others	6,510	UXGA 20"(1600×1200)
34	19"TFT NEC Mitsubishi 195V and others	5,460	SXGA 19"(1280×1024)
35	17"TFT SHARP, Samsung	4,830	SXGA 17"(1280×1024)
36	15"TFT SHARP LLT15G3 and others	4,725	XGA 15"(1024×768)
37	Wall mount bracket (For 15"~24", VESA standard)	3,465	Removing fee ¥2,000 is required in case you don't need the stand.

⑦ Digital Signage

(Price:Yen)

No.	Items	Price	Reference
38	32"TFT Samsung HK32V001	27,300	WXGA60 32" (1366×768)
39	Wall mount bracket LW-37 (For 32", VESA standard)	5,985	

⑧ iPad

(Price:Yen)

No.	Items	Price	Reference
40	Apple iPad MB293J/A Wifi 32GB	6,825	Wi-Fi model

⑨ Mobile broadband

No.	Items	Price	Reference
41	Emobile D02HW USB Modem	7,350	for Windows XP, Vista, 7, MacOS10.4~10.6
42	WiMAX MW-U2510/DM	7,350	for Windows XP, Vista, 7, MacOS10.4~10.6
43	PocketWifi D25HW	8,925	for Windows XP, Vista, 7, MacOS10.4~10.6

⑩ Priters

(Price:Yen)

No.	Items	Price	Reference
44	(Inkjet) CANON PIXUS IP90	9,660	A4 ※ink included
45	(Inkjet) EPSON PM-G4500	14,175	A3 ※ink included
46	(Black&White Laser) CANON Satera LBP3000	13,440	A4※toners included
47	(Black&White Laser) CANON Satera LBP3970	37,800	A3 (network capable)※toners included
48	(Color Laser) CANON LBP5400 **	34,650	A4 (network capable)
49	(Color Laser) CANON LBP5700 or 5910 **	126,000	A3 (network capable) ※installation & dismantlement work fee included

\*\* No additional fee up to 500 prints. More than 501 prints, /24 per print is added.

⑪ Network equipment

(Price:Yen)

No.	Items	Price	Reference
50	(HUB) Melco LSW-GT-8NSR	1,785	10/100/1000M 8 port Switching HUB
51	(HUB) Melco LSW10/100-8H	1,680	10/100M 8 port Switching HUB
52	(router) NTT-ME MN8300	2,940	ADSL/FTTH/CATV broadband router

## Catering Service for Booths

In order to enhance services available for visitors, a catering service will be available at Inter BEE, providing snacks and beverages to booths when requested. If you wish to have catering delivered to your booth, fill in the Booth Catering Service Application and return the form to Nilax Corporation by Friday, Nov. 11. We hope that each exhibitor will make use of this service to facilitate successful business meetings and transactions with important clients and / or visitors.

### Menu

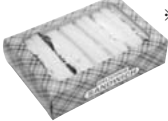
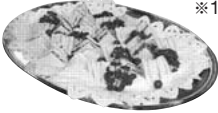
Menu	Serving style	Price (excluding consumption tax)
Coffee (10 cups per service)	Paper cup	¥180
	Ceramic cup	¥330
Iced coffee (10 cups per service)	Paper cup	¥180
	Ceramic cup	¥330
Tea (10 cups per service)	Paper cup	¥180
	Ceramic cup	¥330
Iced tea (10 cups per service)	Paper cup	¥180
	Ceramic cup	¥330
Oolong tea (10 cups per service)	Paper cup	¥180
	Ceramic cup	¥330
Orange juice (10 cups per service)	Paper cup	¥180
	Ceramic cup	¥330
Evian	330ml PET bottle	¥150
Perrier	330ml glass bottle	¥350
House wine (bottle and glasses)	Red	¥3,200
	White	¥3,200
Beer	Canned	¥450
Pastries (servings for 10)	 ※1	¥3,000
Sandwiches (boxed, single serving)	 ※1	¥500
Sandwiches platter (servings for 10)	 ※1	¥3,000
Assorted cookies		¥1,000

※1 Sample Image

※2 If you have any requests and inquiries, please contact following address.

**Contact:**

Nilax Mr. Hori 2-1 Nakase Mihama-ku, Chiba-shi, Chiba 261-0023, Japan  
TEL: +81-43-296-0512



## Internet Connection

Exhibitors who require Internet connection service, are required to submit the “Application for Internet Connection” to Makuhari Messe by Friday, October 14.

### ■ Internet connection (100 Mbps)

Type	Fee (including consumption tax)	Remark
Combination	¥84,000	Including line, provider and router (HUB is not included)
Only lines	¥73,500	Provider, router and HUB is not included
dynamic IP	¥5,250	
static IP-1	¥31,500	
static IP-8	¥52,500	
Router	¥5,250	

### ■ ADSL Line

Type	Fee (including consumption tax)	Remark
Combination	¥52,500	Including line, provider and router (HUB is not included)
Only lines	¥42,000	Provider, router and HUB is not included
dynamic IP	¥5,250	
static IP-1	¥21,000	
static IP-8	¥31,500	
Router	¥5,250	

Others

- ※ The Management Office makes no guarantees regarding unrelated line or provider problems.
- ※ Provider for type of “Combination” is dynamic IP. If you require “static IP”, please apply for “Line only”, “Static IP” and Router.
- ※ Exhibitors must prepare equipment such as LAN cables and LAN adapters to connect broadband routers to PCs

## Temporary Telephone Line Service

Exhibitors who require temporary telephone or fax line, are required to submit the “Application for Telephone Line” to Murayama Inc by September 22.

### ■ Usage Period

Line type	Usage period
Analog	9:00 a.m. on Nov. 15 to 5:00 p.m. on Nov. 18
ISDN64	9:00 a.m. on Nov. 15 to 5:00 p.m. on Nov. 18

### ■ Fees (including both basic and telephone call charge) Per Line

Line type	Fee
Analog	¥31,500 (tax included)
ISDN64	¥42,000 (tax included)

Notes:

\* Exhibitors applying for an ISDN64 line may have a second telephone number upon request, for an additional fee of ¥10,500 (tax included).

### ■ Telephone

Exhibitors applying for analog lines will receive an NTT telephone for in-booth usage free of charge. If a telephone is not required, the module terminal can be used as an outlet.

### ■ Fax Machine

Fax machine rentals (thermal paper output) will be available.

### ■ International Calls

Exhibitors using analog lines may make international calls through their preferred international carrier. In the case of ISDN64 lines, international calls and / or faxes can be made only if exhibitors pre-register each individual line with their preferred international carrier. Said application procedures must be completed by the exhibitor.

### ■ Others

Telephone lines come up from the floor pit, and once installed relocation of telephone line is quite difficult because the displays and / or carpet cannot be moved. Therefore, please precisely clarify the telephone installation position in a “Temporary Telephone Position Diagram”. Telephones will be installed by Nippon Telegraph & Telephone East Corp. (NTT East). Persons other than NTT East personnel are forbidden to relocate a telephone without permission, to disconnect a line, or to conceal a telephone within the hall. Any expenses originating from rule violations by an exhibitor shall be borne by the exhibitor.

## Antenna Installation

In case the exhibitor wants to receive TV signals for demonstration purposes, please submit the "Application for Antenna Installation" to Makuhari Messe by Friday, September 22.

### ■ Category of Signals

Digital Terrestrial Broadcasting and others	Tokyo Wave of CH-7 + MX TV, Chiba Television, Hoso Daigaku
CS-IF	One coaxial cable from the parabolic antenna connects to the JCSAT-3 or JCSAT-4A. The receiver tuner performs switching of both the antenna power supply and vertical/horizontal polarized waves.
BS-IF(Digital) 110°CS-IF	For BS-IF(Digital) and 110CS please apply separately.
Note	If an exhibitor needs special signals which are not described on the "Antenna Installation Application" Form, such as Broadcast- satellite transmission wave, please indicate the requirements in the blank space on the application form. The appointed antenna installation company will contact the exhibitor later.

### ■ Delivery of Signal

A coaxial cable with RF-typed connector will be provided at the designated place in the exhibition booth.

### ■ Installation

The installation construction is scheduled to start on Sunday, November 13 and to be completed in the morning of Tuesday, November 15. Since there is a possibility that the above installation completion schedule will be delayed because of booth construction, please discuss with Information Machine Room in Makuhari Messe, Inc. which is the appointed installation company. Dismantling will start at 5:00 p.m., Friday, November 18.

### ■ Installation Fee

For distribution, amplification, etc. of signals other than the basic signals and signals between booths, a separate fee will be charged and installation costs will be billed to you by Tofuna Eizo Inc. The payment deadline is one month from the issuance of the bill.

For signals other than the signals in the application form, bringing in antennas, etc., there will also be a separate fee, please contact Information Machine Room in Makuhari Messe, Ltd. for further details.

Signal Category		Fee(Number of Lines)
Digital Terrestrial Broadcasting		¥73,500
BS-IF	Digital	¥94,500
CS-IF	JCSAT-3	¥147,000
	JCSAT-4A	¥147,000
	JCSAT-110	¥94,500

### ■ Contact

Inquiries:  
Makuhari Messe Information Machines Room / Tofuna Eizo Inc.  
Contact: Shishikura, Beppu 2-1 Nakase, Mihama-ku, Chiba-ken, 261-0023 JAPAN  
Tel: +81-43-296-0536 Fax: +81-43-296-0012

## Hotel Reservations

Rooms in the following hotels are available at a special discount rate from Sunday, November 13 to Saturday, November 19.

Hotel	Room type	Order No.	Special price (including service charge and tax)		Location / Transportation
			Room fee	With breakfast	
APA Hotel & Resort (Tokyo-bay-makuhari) 2-3, Hibino, Mihama-ku, Chiba-shi TEL: 043-296-1111 FAX: 043-296-0977	Single room	A	¥11,025	¥12,075	9 min. on foot from Kaihin Makuhari Station (JR Keiyo line) 2 min. on foot to Makuhari Messe Hotel parking: ¥800 per night
	Twin room		¥11,025	¥12,075	
Hotel New Otani Makuhari 2-2, Hibino, Mihama-ku, Chiba-shi TEL: 043-297-7777 FAX: 043-297-7788	Single room	B	¥17,850	¥19,950	5 min. on foot from Kaihin Makuhari Station (JR Keiyo line) 4 min. on foot to Makuhari Messe Hotel parking: free of charge for lodger
	Twin room		¥11,025	¥13,125	
Hotel Francs 2-10-2, Hibino, Mihama-ku, Chiba-shi TEL: 043-296-2111 FAX: 043-296-2120	Single room	C	¥11,550	¥12,600	4 min. on foot from Kaihin Makuhari Station (JR Keiyo line) 3 min. on foot to Makuhari Messe Hotel parking: contact Nippon Travel Agency
	Twin room		¥9,975	¥11,025	
Hotel Green Tower Makuhari 2-10-3, Hibino, Mihama-ku, Chiba-shi, 261-0021 TEL: 043-296-1122 FAX: 043-296-1125	Single room	D	¥9,450	¥11,025	4 min. on foot from Kaihin Makuhari Station (JR Keiyo line) 3 min. on foot to Makuhari Messe Hotel parking: free of charge for lodger
	Twin room		¥8,925	¥10,500	
Hotel Springs Makuhari 1-11, Hibino, Mihama-ku, Chiba-shi TEL: 043-296-3111 FAX: 043-296-3795	Single room	E	¥9,450	¥10,500	4 min. on foot from Kaihin Makuhari Station (JR Keiyo line) 8 min. on foot to Makuhari Messe Hotel parking: ¥500 for entire stay
	Twin room		¥8,400	¥9,450	
Hotel the Manhattan 2-10-1, Hibino, Mihama-ku, Chiba-shi TEL: 043-275-1111 FAX: 043-275-1197	Standard single	F	¥16,800	¥17,850	5 min. on foot from Kaihin Makuhari Station (JR Keiyo line) 5 min. on foot to Makuhari Messe Hotel parking: free of charge for lodger
	Standard twin		¥11,550	¥12,600	
	Deluxe single		¥19,950	¥21,000	
	Deluxe twin		¥10,500	¥11,550	
FAMY INN Makuhari 1-33-3, Makuhari Hongo, Hanamigawa-ku, Chiba-shi Tel: 043-271-5555 FAX: 043-271-5772	Single room	G	¥7,500	¥8,100	5 min. from Makuhari-hongo (JR Sobu / Keiyo line) Shuttle bus to Makuhari Messe Hotel parking: free of charge for lodger (for first 40)
Sala Inagekaigan Hotel 3-20-40, Takasu, Mihama-ku, Chiba-shi Tel: 043-277-9330 FAX: 043-278-9361	Single room	H	¥7,500	¥8,000	2 min. on foot from Inagekaigan Station (JR Keiyo line) 5 min. via JR line and 8 min. on foot to Makuhari Messe Hotel parking: ¥525 per day
	Twin room		¥6,000	¥6,500	
Hotel New Tsukamoto 7-1, Chiba minato, Chuo-ku, Chiba-shi Tel: 043-243-1111 FAX: 043-242-1250	Single room	I		¥6,300	2 min. on foot from Chiba Minato Station (JR Keiyo line) 9 min. via JR line and 8 min. on foot to Makuhari Messe Hotel parking: free of charge for lodger (for first 30)
	Twin room			¥5,775	

## Notes:

1. Single room charges for Hotel the Manhattan and Hotel New Otani Makuhari are quoted per person for twin or double room use.
2. Please make a reservation as early as possible, since room availability is limited.

**(1) Room fees include followings:**

1. Service charge and tax per night and per room
2. Twin Room rate charges are quoted per night and per person

**(2) How to apply**

1. Please fill in the Application for Hotel Reservations and submit it to Nippon Travel Agency.
2. Application deadline is October 21, 2011.

**(3) Payment**

1. Payment is only acceptable by credit card.
2. Reservation will be completed after charges be settled. In case of nonpayment, not confirm Hotel reservation.

**(4) Cancellation**

In case of cancellation, the room deposit will be refunded after deduction of the following cancellation charges. All changes and cancellations must be made by fax to Nippon Travel Agency Co., Ltd. Changes / cancellations will not be accepted by telephone.

## Contact:

Nippon Travel Agency Co., Ltd.  
Telephone : +81-43-227-2307 FAX : +81-43-225-2241  
Application deadline : October 21  
Person in charge : Nakao / Katsuhiko Mukasa  
E-mail : ibee\_2011@nta.co.jp  
Business hours : Monday to Friday, 9:30 a.m. to 6:00 p.m.

No. of days prior to booking	Cancellation Fee
21 days	No charge
8 - 20 days	10% of fee per room
1 - 7 days	20% of fee per room
Date of booking	100% of fee per room
No notification	100% of fee per room

## Food / Beverage Tickets

Makuhari Subcenter Food / Beverage Tickets will be sold. Exhibitors who require Food / Beverage Tickets, are required to submit the “Application for Food / Beverage Tickets” to Makuhari Messe by Friday, October 14 or purchase on site.

### ■ About the Food and Beverage Tickets

1. These tickets are valid until December 31, 2011.
2. Tickets are issued in ¥1,000 packets (three ¥250 tickets, two ¥100 tickets and one ¥50 ticket each).
3. They are redeemable at restaurants and cafeterias on the exhibition site, as well as at restaurants in Makuhari Messe, Hotel Green Tower Makuhari, Hotel Springs Makuhari, Hotel New Otani Makuhari, World Business Garden (WBG) , Makuhari Techno Garden (MTG) , Messe Amuse Mall, aune MAKUHARI, su:k Kaihin Makuhari, Pal Plaza Makuhari, Hotel the Manhattan, Hotel Francs, APA Hotel & RESORT, Plena Makuhari, MITSUI OUTLET PARK MAKUHARI and JR Kaihinmakuhari. For more details, please see the website: (<http://www.m-messe.co.jp/en/newcityguide/index.html>)

### ■ How to Order

1. Purchasing in advance of the exhibition (Tickets will be mailed following bank transfer confirmation).  
To purchase food and beverage tickets in advance, exhibitors should submit the Application. Tickets, a temporary receipt and a refund application form will be mailed following bank transfer confirmation. Applications will be invalid if transfers are not confirmed by November 1, after which tickets must be purchased on-site (cash only).
2. On-site (Cash only)  
Food and beverage tickets can be purchased (cash only) from November 12 to November 18 at the following locations:  
Makuhari Messe Inc. : International Conference Hall, 1F

### ■ Refund Policy

After the show, the full amount paid for on-site food and beverage tickets will be refundable if the exhibitor submits the temporary receipt, a refund application form and the unused tickets to Makuhari Messe Inc. within 2 weeks after the closing the show.

A receipt will be issued, and the total amount will be deposited into a bank account designated by the exhibitor. However, there are no refunds after the receipt issued.

Refunds cannot be made in cash.



## Lunch box Delivery Service

---

Lunch box / beverage delivery service to your booth will be available during the exhibition period. Exhibitors who request delivery service, are required to submit the "Application for lunch box Delivery Service" to Wako Sangyo Co., Ltd. by November 11.

---

### ■ Delivery items

#### 1. Daily lunch special

Choice of ¥900-lunch, ¥1,100-lunch and ¥1,400-lunch

Note: Special party lunch plan will be available upon request.

#### 2. Beverages

·Oolong tea (2L plastic bottle) : ¥500

·Oolong tea (500ml plastic bottle) : ¥150

·Mineral water (2L plastic bottle) : ¥450

·Japanese tea (500ml plastic bottle) : ¥150

·Beer (350ml can) : ¥ 400

·Paper cup (small) : ¥ 20

·Coffee maker set : ¥ 20,000

\*This set includes coffee beans, paper cups, sugar, muddlers, milk and paper filters for 120 cups of coffee.

\*Please prepare a socket (950w) inside your booth.

Above prices include 5% consumption tax.

---

### ■ Delivery time

Lunch / beverage will be delivered by 11:45 a.m. to your booth.

---

### ■ How to pay

Catering staff will visit your booth to collect the payment (in cash) in the afternoon of last day of exhibition.

If you wish to pay by bank transfer, please specify in the application.

## Receptionist / Interpreter

---

If you require part-time staff to carry out reception duties etc. at your company booth, please fill in the required fields in the “Application Form for Reception Staff and Interpreters”, and send it to Ken & Staff Co., Ltd. by 28th October.

---

### ■ Rates

Booth receptionist : ¥16,443 including tax (up to 8 hours per day)

Interpreter for Booth reception (English - Japanese) : ¥30,303 including tax (up to 8 hours per day)

Interpreter for Business meeting (English - Japanese) : ¥58,023 including tax (up to 8 hours per day)

---

### ■ Remarks

① The above amount is for up to 8 hours work, and for every one hour of overtime, we will charge one and one-quarter (1.25) times their regular pay of 1,650 yen (reception work), 3,300 yen (interpreting) and 6,600 yen (interpreting for business negotiations).

This also includes meal charges, traffic costs, and 5% consumption tax.

② We can provide a separate estimate relating to interpreting services for various foreign languages.

## Booth Photography

---

Exhibitors who require booth photography, are requested to submit the Application for Booth Photography by Friday, November 4.

---

### ■ Service contents

1. Camera to be used  
Digital camera (approximately 8 mega pixels)
2. Rate  
¥13,650 (incl. consumption tax) per shot  
Including one cabinet print.  
Delivery fee will be charged separately.
3. Shooting date and time  
According to your preference
4. Delivery  
Photo data to be delivered on Friday, November 25 (planned)

## Booth Cleaning

---

Exhibitors requiring booth-cleaning services must submit the Application for Booth cleaning to Chiba-Pref. Bldg. maintenance corp. by Friday, November 4.

### (1) Cleaning Charge

¥1,890 (tax included) per booth (9 m<sup>2</sup>) Specify the number of booths to be cleaned when in the application form.

### (2) Period available

Daily after 5:30 p.m. from November 15 to November 17.

### (3) Cleaning method

Vacuuming or mopping the booth floor (cleaning of display counters, showcases and products not included)