

Services Related to Booth Operation

05-1 Transport Service

05-1-1 Transport, Load-in and Load-out Services

05-2 Rental Fixtures

05-2-1 Package Booth Service & Rental Fixtures

05-2-2 PC Rental

05-3 Infrastructure Services

05-3-1 Internet Connection

05-3-2 Temporary Telephone Line Service

05-3-3 Antenna Installation

05-4 Booth Management Services

05-4-1 Hotel Reservations

05-4-2 Food / Beverage Tickets

05-4-3 Lunch Box Delivery Service

05-4-4 Catering Service for Booths

05-4-5 Receptionist / Interpreter

05-4-6 Booth Photography

05-4-7 Booth Cleaning

05

Transport, Load-in and Load-out Services

■ Transport within Japan

Exhibitors requiring cargo collection services on-site and single-lot, small package delivery are requested to submit “Application for Transport within Japan” to Ishikawa-Gumi, Ltd. by Friday, October 16.

When you applied for single-lot, small package delivery service, please clearly indicate “Attention to Inter BEE 2014” together with the exhibitor’s name, hall number and booth number on address labels and cargo receipts, and send a package(s) with address labels to Ishikawa-Gumi by Friday, October 23.

“Small packages” are packages with maximum exterior dimensions (W + D + H) of 120cm and a maximum weight of 15kg.

Inter BEE 2015	
Booth Number	1 2 3 4
Exhibitors Name	○○○○Ltd.
Person in Charge	Mr. Taro Yamada

Courier services are available at the Courier Service Center, located in the north conference room in Exhibition Hall 6.

■ Load-in / Load-out Services

Exhibitors requiring loading / unloading services on the show site, such as unloading exhibits from trucks, delivering them to exhibition booths, unpacking and re-packing, removal from the exhibition booth, and loading onto trucks must fill in the “Application for Load-in / Load-out Services” and submit it to Ishikawa-Gumi, Ltd. by Friday, October 16.

Operation and forklift charges:

	Fee (Without tax)
Worker / person	¥4,725 / hour
2.5-ton forklift	¥15,750 / 30 min.
5.0-ton forklift	Estimated based on contents of loading
Crane	Estimated based on contents of loading

Package Booth Service & Rental Fixtures

Three types of package booth are available as described below. Exhibitors who require package booth and / or rental fixtures must fill in the “Application for Booth Display & Rental Fixtures” and submit it to Mruyama Inc. by Friday, October 16.

■ Package Booth

Please choose one of the following booth types:

1-Booth Package

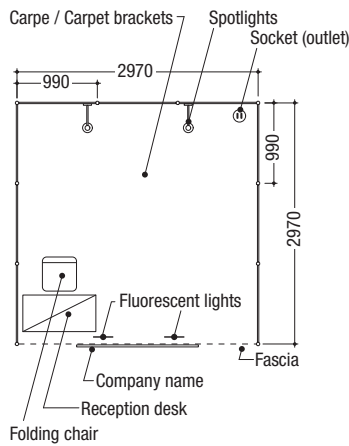

No.	item	Quantity
21	Carpet	1 Booth
22	Carpet brackets	3m
4	Fascia	3m
29	Reception desk	1
36	Folding chair	1
	Company name display	1
57	Spotlights	2
58	Fluorescent light	2
59	Socket (outlet)	1

(including tax) **¥75,600**

2-Booth Package

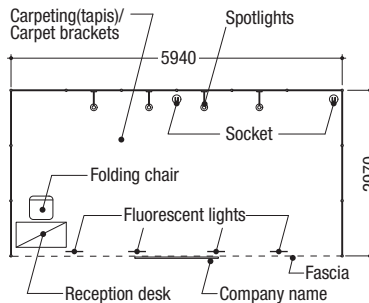
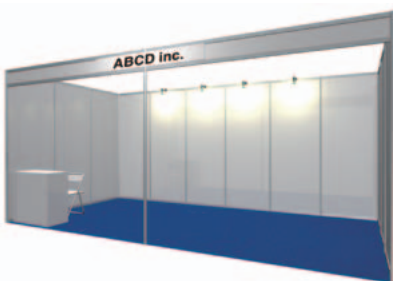

No.	item	Quantity
21	Carpet	2 Booth
22	Carpet brackets	6m
4	Fascia	6m
29	Reception desk	1
36	Folding chair	1
	Company name display	1
57	Spotlights	4
58	Fluorescent light	4
59	Socket (outlet)	2

(including tax) **¥118,800**

3-Booth Package

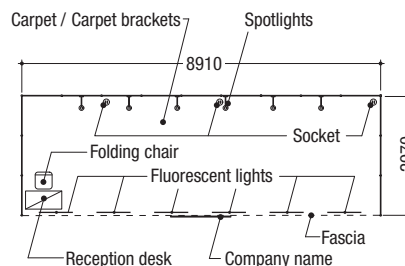
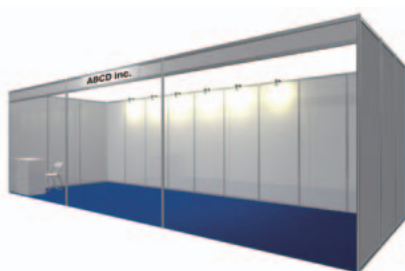

No.	item	Quantity
21	Carpet	3 Booth
22	Carpet brackets	9m
4	Fascia	9m
29	Reception desk	1
36	Folding chair	1
	Company name display	1
57	Spotlights	6
58	Fluorescent light	6
59	Socket (outlet)	3

(including tax) **¥162,000**

※ For exhibitors whose booths are located at the corner. If the booth is located at the corner, wall panels facing the aisle will not be installed and only a fascia will be set up. Company name display will be placed on the front side of the fascia. Exhibitors who require to set up wall panel, are required to contact the Management Office. (No additional cost is required)

Package Booth Service & Rental Fixtures

Package Booth

Please choose one of the following booth types:

Premium Package Booth <1 booth>

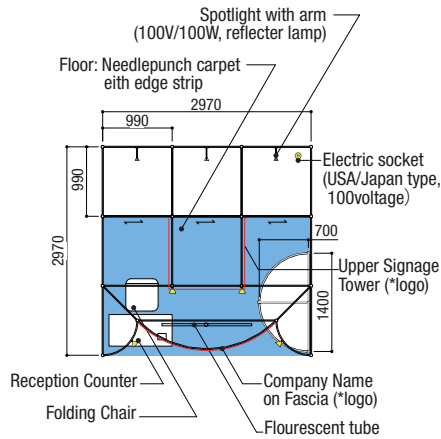

No.	item	Quantity
3	Octanorm display counter with sliding doors (without key)	3
21	Floor: Needlepunch carpet eith edge strip	1
22	Wall coloring	9
23	Carpet edge strip	3
Optional Display	Fascia	1
Optional Display	Company Name on Fascia (*logo)	1
Optional Display	Upper Signage Tower (*logo)	1
29	Reception Counter	1
36	Folding Chair	1
54	Business card box	1
57	Spotlight (100V/100W, reflector lamp)	7
58	Flourescent tube	1
59	Electric socket (USA/Japan type, 100voltage)	1

(including tax) **¥237,600**

Premium Package Booth <2 booths>

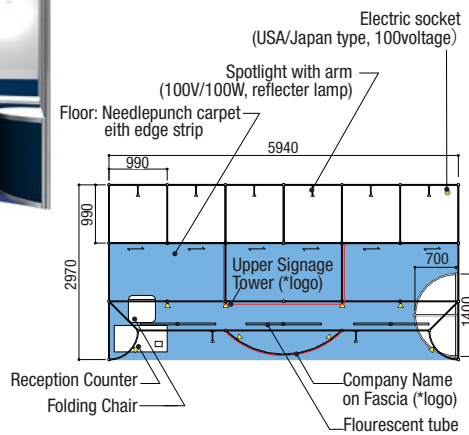
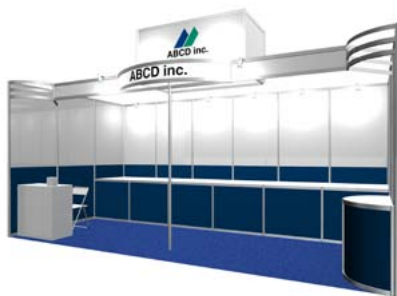

No.	item	Quantity
3	Octanorm display counter with sliding doors (without key)	6
21	Floor: Needlepunch carpet eith edge strip	2
22	Wall coloring	14
23	Carpet edge strip	6
Optional Display	Fascia	1
Optional Display	Company Name on Fascia (*logo)	1
Optional Display	Upper Signage Tower (*logo)	1
29	Reception Counter	1
36	Folding Chair	1
54	Business card box	1
57	Spotlight (100V/100W, reflector lamp)	10
58	Flourescent tube	3
59	Electric socket (USA/Japan type, 100voltage)	1

(including tax) **¥432,000**

Premium Package Booth <3 booths>

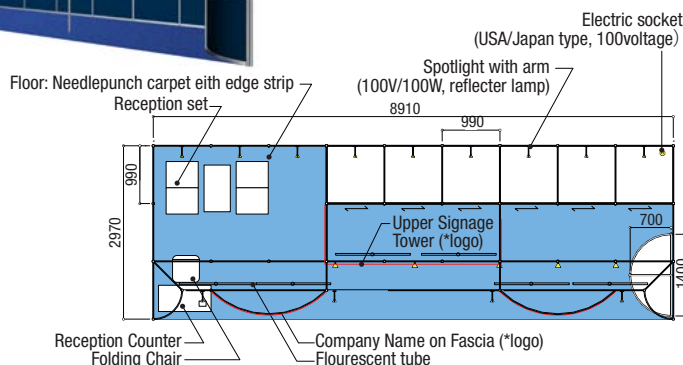
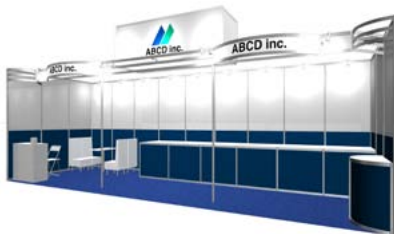

No.	item	Quantity
3	Octanorm display counter with sliding doors (without key)	6
21	Floor: Needlepunch carpet eith edge strip	3
22	Wall coloring	19
23	Carpet edge strip	9
Optional Display	Fascia	1
Optional Display	Company Name on Fascia (*logo)	1
Optional Display	Upper Signage Tower (*logo)	1
29	Reception Counter	1
36	Folding Chair	1
54	Business card box	1
57	Spotlight (100V/100W, reflector lamp)	16
58	Flourescent tube	6
59	Electric socket (USA/Japan type, 100voltage)	1

(including tax) **¥648,000**

※ Logo data will be provided by Adobe Illustrator (outlined) formatted digital data.

Package Booth Service & Rental Fixtures

Original Booth

Original booth designs are assembled on each exhibitor's selection of standard and specially arranged parts. These sketches are design samples provided for reference purposes. Different designs are also available in the same budget range. For more details on booth design and order placement, please contact Murayama Inc.

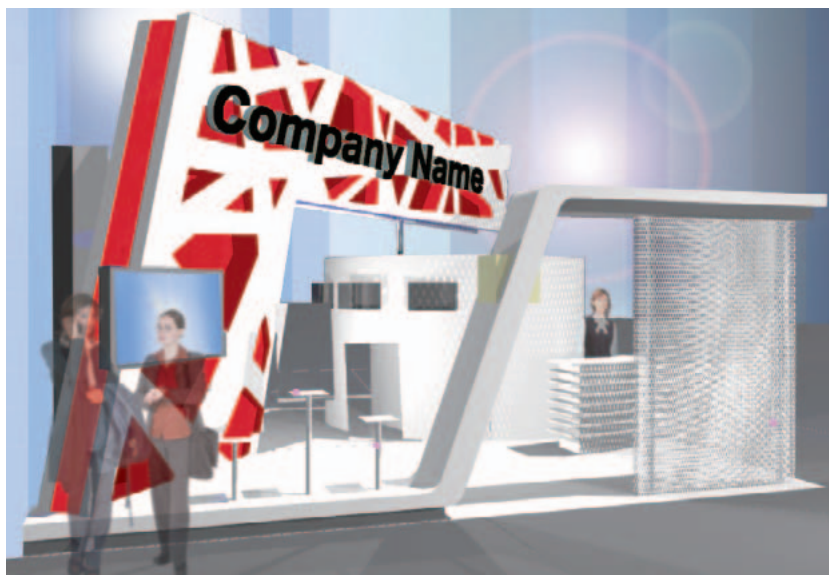

Package Booth Service & Rental Fixtures

Rental Fixtures

Package booths may be installed with additional components according to each exhibitor's selection of items from the following list of Rental Fixtures / Furniture.

(Prices include consumption tax.)

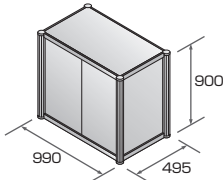
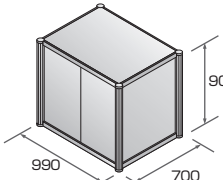
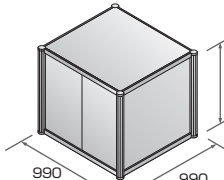
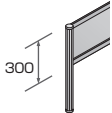
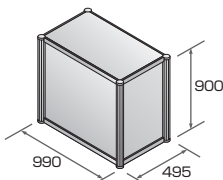
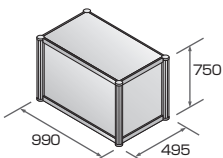
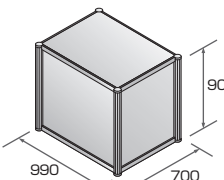
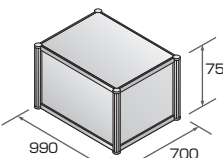
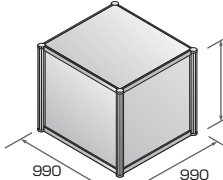
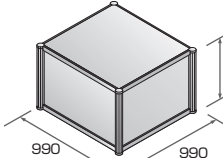
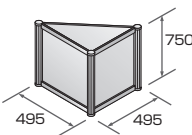
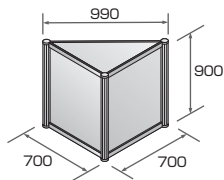
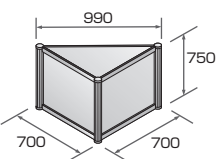
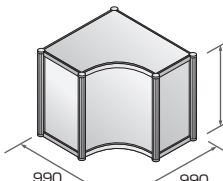
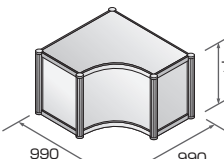
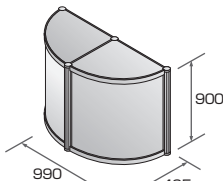
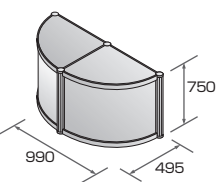
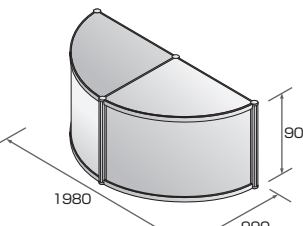
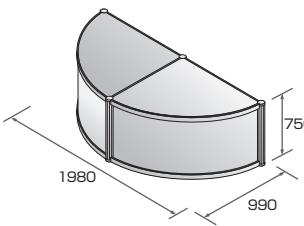
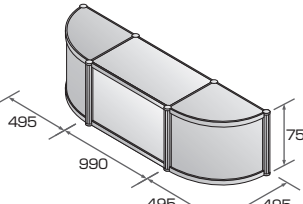
<p>1 Display counter (with storage space)</p>  <p>¥21,600</p>	<p>2 Display counter (with storage space)</p>  <p>¥23,760</p>	<p>3 Display counter (with storage space)</p>  <p>¥27,000</p>	<p>4 Fascia</p>  <p>1m ¥4,320</p>
<p>5 Display counter</p>  <p>¥16,120</p>	<p>6 Display counter</p>  <p>¥14,040</p>	<p>7 Display counter</p>  <p>¥18,360</p>	<p>8 Display counter</p>  <p>¥16,200</p>
<p>9 Display counter</p>  <p>¥21,600</p>	<p>10 Display counter</p>  <p>¥21,600</p>	<p>11 Display counter</p>  <p>¥9,720</p>	<p>12 Display counter</p>  <p>¥16,200</p>
<p>13 Display counter</p>  <p>¥14,040</p>	<p>14 Display counter</p>  <p>¥27,000</p>	<p>15 Display counter</p>  <p>¥24,840</p>	<p>16 Display counter</p>  <p>¥35,640</p>
<p>17 Display counter</p>  <p>¥30,240</p>	<p>18 Display counter</p>  <p>¥37,800</p>	<p>19 Display counter</p>  <p>¥35,640</p>	<p>20 Display counter</p>  <p>¥37,800</p>

Package Booth Service & Rental Fixtures

Rental Fixtures

Package booths may be installed with additional components according to each exhibitor's selection of items from the following list of Rental Fixtures / Furniture.

(Prices include consumption tax.)

<p>21 Floor carpet</p> <p>For samples of the floor carpet and wall color, refer to the manual, Section 05-2-1.7.</p> <p style="text-align: right;">¥19,440 / booth</p>	<p>22 Wall panel color</p> <p>For samples of the floor carpet and wall color, refer to the manual, Section 05-2-1.7.</p> <p style="text-align: right;">¥2,160 / m²</p>	<p>23 Brackets for carpeting</p>  <p style="text-align: right;">¥650 / m</p>	<p>24 Wall panel</p>  <p style="text-align: right;">¥10,800</p>
<p>25 Wall partition</p>  <p style="text-align: right;">¥6,480</p>	<p>26 Door with lock</p>  <p style="text-align: right;">¥30,240</p>	<p>27 Accordion door</p>  <p style="text-align: right;">¥24,840</p>	<p>28 Shelf</p>  <p style="text-align: right;">¥5,400</p>
<p>29 Reception desk</p>  <p>W900×D450×H800</p> <p style="text-align: right;">¥8,640</p>	<p>30 Cut out lettering</p> <p>H50 ¥1,200 / letter H90 ¥1,400 / letter H150 ¥2,160 / letter H200 ¥2,380 / letter H300 ¥3,410 / letter</p>  <p>The above prices are for the specified fonts. The prices for your logos and / or special fonts are available on your request.</p>	<p>31 Explanatory panel</p> <p>*The price will vary according to the volume and the specifications of manuscripts.</p> <p>W1,200×H900 (300 letter) ¥54,000 ~ W900×H600 (250 letter) ¥43,200 ~ W600×H500 (150 letter) ¥37,800 ~</p>	<p>32 Reception set</p>  <p style="text-align: right;">¥15,660</p>
<p>33 Meeting set</p>  <p style="text-align: right;">¥29,400</p>	<p>34 System counter</p>  <p>W600×D600×H1,020</p> <p style="text-align: right;">¥12,960</p>	<p>35 Potted plants</p>  <p>Large: ¥3,780 Medium: ¥2,700 Small: ¥1,300 Flower: ¥1,080</p>	<p>36 Folding chair</p>  <p style="text-align: right;">¥650</p>
<p>37 Meeting set</p>  <p style="text-align: right;">¥25,920</p>	<p>38 Counter chairs</p>  <p>A:H500 B:H600 C:H700</p> <p style="text-align: right;">¥3,240/each</p>	<p>39 Counter chairs</p>  <p>A:H500 B:H600 C:H700</p> <p style="text-align: right;">¥3,780/each</p>	<p>40 Tables</p>  <p>A:W1800×D600×H730 B:W1500×D600×H730 C:W1200×D600×H730</p> <p style="text-align: right;">¥3,780/each</p>

Package Booth Service & Rental Fixtures

Rental Fixtures

Package booths may be installed with additional components according to each exhibitor's selection of items from the following list of Rental Fixtures / Furniture.

(Prices include consumption tax.)

<p>41 Table / white top</p>  <p>A:W800×D450×H600 ¥2,160 B:W600×D600×H600 ¥3,240 C:750×H600 ¥4,320</p>	<p>42 Unit counter</p>  <p>A:W1200×D600×H800 ¥12,960 B:W1500×D600×H800 ¥14,040</p>	<p>43 Island counter</p>  <p>External size:W1500×D600×H920 Internal size:W1450×D530×H290 with light & lock ¥25,920</p>	<p>44 PC chair</p>  <p>¥4,320</p>
<p>45 Stacking chair</p>  <p>A:Blue B:White C:Silver ¥3,240</p>	<p>46 Sign stand</p>  <p>The angle is free. ¥4,320</p>	<p>47 Rack</p>  <p>W900×D450×H1800 ¥7,020</p>	<p>48 Display Stand</p>  <p>W1090×D400×H1180 ¥12,960</p>
<p>49 Fire extinguisher</p>  <p>¥4,320</p>	<p>50 Refrigerator</p>  <p>*Size (m/m) : ¥21,600 A Large: 170 ℓ ¥19,440 B Medium: 100~106 ℓ ¥16,200 C Small: 70~74 ℓ</p>	<p>51 Catalogue stand</p>  <p>A:¥5,940 B:¥1,620</p>	<p>52 Coffee maker</p>  <p>200 cups ¥32,400</p>
<p>53 White cloth</p>  <p>H1000×W2000 ¥1,625 / sheet</p>	<p>54 Business card holder</p>  <p>¥1,620</p>	<p>55 Arm spotlight</p>  <p>100W reflecting bulb ¥3,780</p>	<p>56 Spotlight</p>  <p>100W beam-type bulb ¥3,780</p>
<p>57 Fluorescent light</p>  <p>40W ¥3,780</p>	<p>58 Power socket 100V(E)</p>  <p>2-way outlet w/o earthing ¥3,240 2-way outlet w/ earthing ¥3,780</p>	<p>59 Halogen spotlight</p>  <p>Halogen bulb 300W ¥7,560</p>	<p></p>

※ For details on panel attachment parts, please contact the contractor directly.

Package Booth Service & Rental Fixtures

Rental Fixtures

Package booths may be installed with additional components according to each exhibitor's selection of items from the following list of Rental Fixtures / Furniture.

(Prices include consumption tax.)

<p>60 20.1" LCD Flat Screen Display</p>  <p>●External dimensions: W450×H438×D228mm</p> <p style="text-align: right;">¥ 47,520</p>	<p>61 26" LCD Flat Screen Display</p>  <p>●External dimensions: W682×H565×D266mm</p> <p style="text-align: right;">¥ 63,720</p>
<p>62 30" LCD Flat Screen Display</p>  <p>●External dimensions: W1000×H602×D304mm</p> <p style="text-align: right;">¥ 113,400</p>	<p>63 32" LCD Flat Screen Display</p>  <p>●External dimensions: W786×H606×D297mm</p> <p style="text-align: right;">¥ 113,400</p>
<p>64 37" LCD Flat Screen Display</p>  <p>●External dimensions: W904×H596×D87mm</p> <p style="text-align: right;">¥ 120,960</p>	<p>65 40" LCD Flat Screen Display</p>  <p>●External dimensions: W1055.4×H608.6×D140mm</p> <p style="text-align: right;">¥ 127,440</p>
<p>66 52" LCD Flat Screen Display</p>  <p>●External dimensions: W1572×H923×D126mm</p> <p style="text-align: right;">¥ 170,640</p>	<p>67 LCD Television Stand</p>  <p style="text-align: right;">¥ 9,720</p>
<p>68 DVD Player</p>  <p>●External dimensions: W420×H55×D283mm</p> <p style="text-align: right;">¥ 12,960</p>	<p>69 P.A. System</p>  <p>Mixer / amp, 2 speakers, wired microphone</p> <p style="text-align: right;">¥ 35,100</p>

※ Murayama Inc. Offers a wide variety of projectors and screens to meet your specific needs.



Package Booth Service & Rental Fixtures

■ Color samples



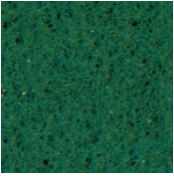
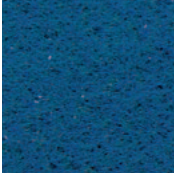
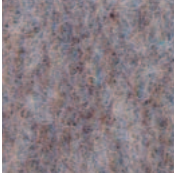
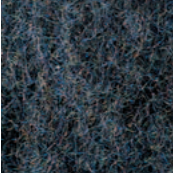

Carpet colors

※For those exhibitors who have applied for the package plan, the carpet will be included for FREE.

※For exhibitors who have applied for standard booth only, the carpet will be chargeable.

Red(731) 	Orange(702) 	Green(705) 
Blue(712) 	Gray(720) 	Black(606) 

Wall colors (Chargeable)

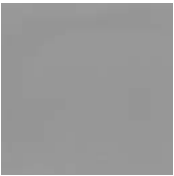
1.Yellow (KS118) 	2.Red (KS113) 	3.Green (KS126) 	4.Skyblue (KS132) 
5.Blue (KS137) 	6.Navy (KS139) 	7.Gray (KS103) 	8.Black (KS106) 

Package Booth Service & Rental Fixtures

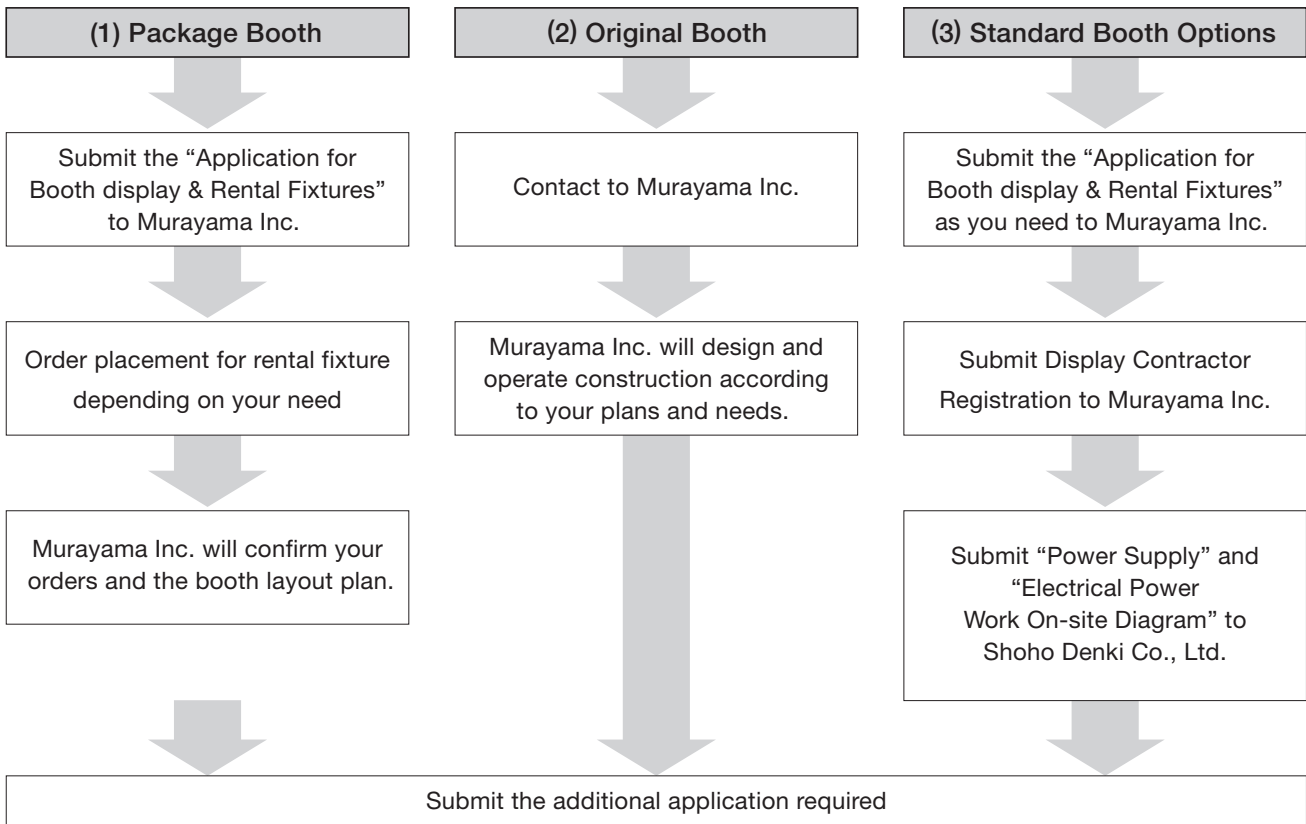

Note:

Exhibitors applying for the package booth are not required to submit the “Application for Power Supply the Electrical Power Work On-site Diagram” or the “Display Contractor Registration”. The package booth plan does not include costs related to electrical work or electric consumption charges.

Exhibitors who require PC rental service, are requested to submit the "Application for PC Rental" to Kissei Comtec by Friday, October 30. Due to a rush of applications for PC rentals immediately before the exhibition, we may not be able to meet all requests. Please submit your application as early as possible.

Dates:

Delivery: 10:00 a.m. – on Tuesday, November 17.

Pick-up: 5:00 p.m. – 7:00 p.m. on Friday, November 20.

Separate fee estimates will be provided for exhibitors requiring a rental PC(s) delivery at a time other than that specified above.(Contact Kissei Comtec for further details.)

Rental Fees

Packing / unpacking fees and on-site work fees are not included in the list.

The list shows only part of the stock available. Exhibitors should contact Kissei Comtec directly to enquire about items not on the list, such as other PCs, expansion cards, peripherals and networking equipment. The price list below includes consumption tax. Prices in the list below are set especially for this exhibition. (Delivery / pickup on-site fees included)

Packing / unpacking fees and on-site work fees are not included.

Inter BEE 2015 Rental Price List

① Package Plan (PC rental with popular software installation and Windows Update)

No.	Presentation Plan	Price	OS	Microsoft Office Standard Edition is installed. Presentation tool, "PowerPoint" is available. Please choose from 2007, 2010 and 2013.
P1	DELL Latitude E6510 (English)	12,960	Windows7 Pro 32bit	
P2	DELL OptiPlex 980SFF (English) ※Display is not included.	13,500	Windows7 Pro 32bit	

No.	Internet connection Plan	Price	OS	NOD and the latest version of the Windows update software are installed for the security countermeasure.
P3	DELL Latitude E6510 (English)	12,960	Windows7 Pro 32bit	
P4	DELL OptiPlex 980SFF (English) ※Display is not included.	13,500	Windows7 Pro 32bit	

No.	All in One Plan	Price	OS	Microsoft Office Standard Edition, NOD and the latest version of the Windows update software are installed. Please choose from 2007, 2010 and 2013.
P5	DELL Latitude E6510 (English)	16,200	Windows7 Pro 32bit	
P6	DELL OptiPlex 980SFF (English) ※Display is not included.	17,280	Windows7 Pro 32bit	

② Laptop PC

(Price:Yen)

No.	Items	Price	RAM	CPU	Graphic/VRAM/output-terminal	Drive	OS
1	DELL Latitude E6520(Japanese) (1600×900)	9,720	4GB	Corei7 2.7G	NVIDIA NVS 4200M VGA HDMI(VIDEO output only)	DVDSuperMulti	Win7-Pro 32bit
2	DELL Latitude E6510(English) (1600×900)	9,180	4GB	Corei7 2.66G	onboard graphics VGA DisplayPort	DVDSuperMulti	Win7-Pro 32bit
3	LENOVO ThinkPad T540p 20BF-AOXTJP (Japanese) (1920×1080)	11,880	8GB	Core i7 2.7G	NVIDIA Geforce GT 730M VGA MiniDisplayPort	DVDSuperMulti	Win8.1u-Pro 64bit or Win7 Pro 64bit
4	Toshiba dynabook B551(Japanese) (1366×768)	8,640	2GB	Core i5 2.3G	onboard graphics VGA	DVDSuperMulti	Win7-Pro 32bit
5	HP ProBook 450 G1(Japanese) (1366×768)	10,260	4GB	Corei5 2.5G	onboard graphics/HDMI VGA (No screw holes for the port)	DVDSuperMulti	Win8.1u-Pro 64bit or Win7-Pro 32bit/64bit
6	Apple MacBook Pro MD103J/A(Japanese) (1440×900)	16,200	4GB	Core i7 2.3G	GeForce GT 650M Thunderbolt	DVDSuperMulti	OS X (10.8)
7	Expansion Memory 1024MB	540	The theft of laptop PCs has been on the increase at the exhibition. We recommend you use security cables or keep PCs in a cabinet which can be locked every day after the exhibition.				
8	Expansion Memory 2048MB	756					
9	Security cable	3,240					

③ Desktop PC

(Price:Yen)

No.	Items	Price	RAM	CPU	Graphic/VRAM/output-terminal	Drive	OS
10	DELL Optiplex 980SFF (Japanese)	9,720	4GB	Corei7-860 2.8G	Radeon HD 3450 256MB VGA DVI	DVDSuperMulti	Win7-Pro 32bit
11	DELL Optiplex 980SFF (English)	9,720	4GB	Corei7-860 2.8G	Radeon HD 3450 256MB VGA DVI	DVDSuperMulti	Win7-Pro 32bit
12	HP EliteDesk 800G1 SF/CT	11,880	16GB	Corei7 3.4G	onboard graphics VGA DisplayPort×2	DVDSuperMulti	Win8.1u-Pro 64bit or Win7-Pro 32bit/64bit

④ Software Rental

No.	Items	Price	Reference
13	MS Office2007/2010/2013 Professional Plus	2,700	Japanese / English(Windows only) An extra installation fee will be charged.
14	MS Office2007/2010/2013 Standard	2,160	Japanese / English(Windows only) An extra installation fee will be charged.
15	Canon IT Solutions Nod32 AntiVirus	Free	Japanese / English(Windows only) An extra installation fee will be charged.
16	Symantec EndpointProtection	540	Japanese / English(Windows only) An extra installation fee will be charged.
17	Software installation fee per unit	2,160	
18	Data erasure software Ultra-X, Inc. Flash Erase ※2	540	

※2 Date erasure process will take approximately 2hours.

⑤ LCD Monitor

No.	Items	Price	Reference
19	24" TFT Mitsubishi MDT241WG and others	15,120	WUXGA 24"(1920×1200)
20	23.6" TFT widescreen LCD display iiyama ProLite E2473HS-2 others	7,884	FHD 23.6"(1920×1080)
21	19" TFT NEC Mitsubishi 194LM and others	5,616	SXGA 19"(1280×1024)
22	17" TFT SHARP Samsung740N PLUS others	4,968	SXGA 17"(1280×1024)
23	Wall mount bracket For 15" 24" VESA standard	1,404	Monitor perestal removal fee is 2,000yen

⑥ Touch screen

(Price:Yen)

No.	Items	Price	Reference
24	Eizo Multitouch 23" FlexScan T2381W_B	11,556	FHD 23.0"(1920×1080) Windows8 · 7 support

⑦ Printer

(Price:Yen)

No.	Items	Price	Reference
25	Inkjet CANON PIXUS IP100	8,856	A4 ※ink included
26	Inkjet CANON PIXUS IP4830	12,744	A4 ※ink included
27	Black&White Laser CANON Satera LBP3000B	13,824	A4 ※toners included
28	Black&White Laser CANON Satera LBP8630	39,960	A3 (network capable) ※toners included
29	Color Laser CANON LBP 5910 ※4	129,600	A3 (network capable) ※installation & dismantlement work fee included

※4 No additional fee up to 500 prints. More than 501prints, ¥23 per print is added.

⑧ Network equipment

(Price:Yen)

No.	Items	Price	Reference
30	(HUB) ELECOM EHB-UG2A08	2,808	10/100/1000M 8 port Switching HUB
31	(HUB) BUFFALO LSW2-GT-16NSRR	4,104	10/100/1000M 16 port Switching HUB
32	(Router) YAMAHA NVR500	6,588	ADSL/FTTH/CATV broadband router

⑨ Useware

(Price:Yen)

No.	Items	Price	Reference
33	Windows Update	2,160	Important update only
34	Network wiring work, setting up ect.	Ask	Network construction work in your booth
35	Unpacking installation, demolition work	Ask	
36	Installation fee for store sale and free application software	2,160~	

Internet Connection

Exhibitors who require Internet connection service, are required to submit the “Application for Internet Connection” to Makuhari Messe by Friday, October 16.

■ Internet connection (100 Mbps)

Type		Fee (including consumption tax)	Remark
Combination	Type A (Maximum speed 200Mbps)	¥86,400	Including line, provider and router (HUB is not included)
	Type B (Maximum speed 1Gbps)	¥108,000	
Only lines	Type A (Maximum speed 200Mbps)	¥75,600	Provider, router and HUB is not included
	Type B (Maximum speed 1Gbps)	¥97,200	
	dynamic IP	¥5,400	
	static IP-1	¥32,400	
	static IP-8	¥54,000	
	Router	¥5,400	

※ This service (FLET’S Hikari Next) line is one that offers speed of up to 200Mbps and 1Gbps respectively. However, there is no guarantee of the actual communication speed or quality. The on-site communication speed may vary depending on the usage situation. Please consult with the Makuhari Messe Communication Line Officer about other NTT line services that are not described here.

■ ADSL Line

Type	Fee (including consumption tax)	Remark
Combination	¥54,000	Including line, provider and router (HUB is not included)
Only lines	¥43,200	Provider, router and HUB is not included
dynamic IP	¥5,400	
static IP-1	¥21,600	
static IP-8	¥32,400	
Router	¥5,400	

※ This service (FLET’S ADSL MORE-only type) is one which offers speeds of up to 12Mbps. However, there is no guarantee of the actual communication speed or quality. The on-site communication speed may vary depending on the usage situation.

■ Notes

- (1) The above prices are the usage rates for one session (within a month)
- (2) Please make sure to attach a booth plan view that shows your line installation location when you submit your application.
- (3) The Management Office makes no guarantees regarding unrelated line or provider problems.
- (4) Provider for type of “Combination” is dynamic IP. If you require “static IP”, please apply for “Line only”, “Static IP” and Router.
- (5) Exhibitors must prepare equipment such as LAN cables and LAN adapters to connect broadband routers to PCs

Temporary Telephone Line Service

Exhibitors who require temporary telephone or fax line, are required to submit the “Application for Telephone Line” to Murayama Inc by September 25.

■ Usage Period

Line type	Usage period
Analog	9:00 a.m. on Nov. 17 to 5:00 p.m. on Nov. 20
ISDN64	9:00 a.m. on Nov. 17 to 5:00 p.m. on Nov. 20

■ Fees (including both basic and telephone call charge) Per Line

Line type	Fee
Analog	¥32,400 (tax included)
ISDN64	¥43,200 (tax included)

Notes:

* Exhibitors applying for an ISDN64 line may have a second telephone number upon request, for an additional fee of ¥10,800 (tax included).

■ Telephone

Exhibitors applying for analog lines will receive an NTT telephone for in-booth usage free of charge. If a telephone is not required, the module terminal can be used as an outlet.

■ Fax Machine

Fax machine rentals (thermal paper output) will be available.

■ International Calls

Exhibitors using analog lines may make international calls through their preferred international carrier. In the case of ISDN64 lines, international calls and / or faxes can be made only if exhibitors pre-register each individual line with their preferred international carrier. Said application procedures must be completed by the exhibitor.

■ Others

Telephone lines come up from the floor pit, and once installed relocation of telephone line is quite difficult because the displays and / or carpet cannot be moved. Therefore, please precisely clarify the telephone installation position in a “Temporary Telephone Position Diagram”. Telephones will be installed by Nippon Telegraph & Telephone East Corp. (NTT East). Persons other than NTT East personnel are forbidden to relocate a telephone without permission, to disconnect a line, or to conceal a telephone within the hall. Any expenses originating from rule violations by an exhibitor shall be borne by the exhibitor.

Antenna Installation

In case the exhibitor wants to receive TV signals for demonstration purposes, please submit the “Application for Antenna Installation” to Makuhari Messe by Friday, September 25.

■ Category of Signals

Digital Terrestrial Broadcasting and others	Tokyo Wave of CH-7, Chiba Television, Hoso Daigaku
CS-IF	One coaxial cable from the parabolic antenna connects to the JCSAT-3 or JCSAT-4A. The receiver tuner performs switching of both the antenna power supply and vertical/horizontal polarized waves.
BS-IF(Digital) 110°CS-IF	For BS-IF(Digital) and 110CS please apply separately.
Note	If an exhibitor needs special signals which are not described on the “Antenna Installation Application” Form, such as Broadcast- satellite transmission wave, please indicate the requirements in the blank space on the application form. The appointed antenna installation company will contact the exhibitor later.

■ Delivery of Signal

A coaxial cable with RF-typed connector will be provided at the designated place in the exhibition booth.

■ Installation

The installation construction is scheduled to start on Sunday, November 15 and to be completed in the morning of Tuesday, November 17. Since there is a possibility that the above installation completion schedule will be delayed because of booth construction, please discuss with Information Machine Room in Makuhari Messe, Inc. which is the appointed installation company. Dismantling will start at 5:00 p.m., Friday, November 20.

■ Installation Fee

For distribution, amplification, etc. of signals other than the basic signals and signals between booths, a separate fee will be charged and installation costs will be billed to you by Tofuna Eizo Inc. The payment deadline is one month from the issuance of the bill.

For signals other than the signals in the application form, bringing in antennas, etc., there will also be a separate fee, please contact Information Machine Room in Makuhari Messe, Ltd. for further details.

Signal Category		Fee(Number of Lines)
Digital Terrestrial Broadcasting		¥75,600
BS-IF	Digital	¥97,200
CS-IF	JCSAT-3	¥151,200
	JCSAT-4A	¥151,200
	JCSAT-110	¥97,200

■ Contact

Inquiries:
Makuhari Messe Information Machines Room / Tofuna Eizo Inc.
Contact: Shishikura, Yamada 2-1 Nakase, Mihama-ku, Chiba-ken, 261-0023 JAPAN
Tel: +81-43-296-0536 Fax: +81-43-296-0012

Hotel Reservations

Hotel Accommodation

KNT, the official travel agent for the show, has reserved a sufficient number of rooms at hotels (at special rates) near the exhibition site during November 15 – 20.

Requests received are subject to the availability and at the discretion of the hotel. Reservation is made on a first-come, first-served basis.

Hotel Reservation

No	Area (Access to venue)	Name of Hotel (Check in/out)	Address/Tel	Room Type	Price Room Charge	Price With breakfast
①	Makuhari (2 min. walk to the venue)	APA HOTEL & RESORT TOKYO BAY MAKUHARI (14:00/11:00)	2-3, Hibino, Mihama-ku, Chiba 261-8525 TEL:81-43-296-1111 FAX:81-43-296-0977	Single Room	¥12,400	¥13,480
				Twin Room	¥17,440	¥19,600
②	Makuhari (2 min. walk to the venue)	HOTEL NEW OTANI MAKUHARI (14:00/12:00)	2-2, Hibino, Mihama-ku, Chiba 261-0021 TEL:81-43-297-7777 FAX:81-43-297-7788	Single Room	¥18,870	¥19,950
				Twin Room	¥23,040	¥25,200
③	Makuhari (5 min. walk to the venue)	HOTEL FRANCS (14:00/11:00)	2-10-2 Hibino, Mihama-ku, Chiba 261-0021 TEL:81-43-296-2111 FAX:81-43-296-2120	Single Room	¥12,820	¥13,900
				Twin Room	-	-
④	Makuhari (8 min. walk to the venue)	HOTEL SPRINGS MAKUHARI (14:00/11:00)	1-11, Hibino, Mihama-ku Chiba 261-0021 TEL:81-43-296-3111 FAX:81-43-296-3795	Single Room	¥12,720	¥13,800
				Twin Room	¥18,840	¥21,000
⑤	Makuhari (5 min. walk to the venue)	HOTEL GREEN TOWER MAKUHARI (14:00/11:00)	2-10-3, Hibino, Mihama-ku, Chiba 261-0021 TEL:81-43-296-1122 FAX:81-43-296-1125	Single Room	¥11,900	¥12,900
				Twin Room	-	-
⑥	Makuhari (5 min. walk to the venue)	HOTEL THE MANHATTAN (15:00/12:00)	2-10-1 Hibino, Mihama-ku, Chiba 261-0021 TEL:81-43-275-1111 FAX:81-43-275-1197	Single Room	¥17,820	¥18,900
				Twin Room	-	-

Book a hotel ➔ <http://www.knt.co.jp/ec/2015/interbee/en>

Notes:

- All rates include room charge, service charge and taxes.
- Twin Room rate charges are quoted per night and per room.
- In case the hotels listed above are fully booked, KNT will suggest you another hotel of the same class.
- Hotels close to MakuhariMesse tend to be full before the deadline. Early reservation is recommended.
- "KaihinMakuhari" is the nearest station to MakuhariMesse.
- Not all transportation access are noted here. Please check the website of the hotel or contact KNT for further information.
- Hotels with *mark have direct access to & from Narita/Haneda Airport by Limousine Bus. .

For further information >>><http://www.limousinebus.co.jp/en/>

Changes & Cancellation

1. If there are any changes (including name, room type, schedule, etc.), kindly provide written notification to KNT.

2. In case of cancellation, a written notification should be sent to KNT.

The following cancellation fees apply:

No. of days prior to booking	Cancellation Fee
8-20 days before	20% of daily full charge
2-7 days before	30% of daily full charge
1 day before	40% of daily full charge
On the day of stay before 2:00 p.m.	50% of the charge
After the date of stay	100% of daily full charge

Contact:
KNT (Kinki Nippon Tourist CO.,LTD) Attn: Yamaji, Kodama
TEL: +81-43-227-9451 FAX: +81-43-222-9770
E-mail: chiba@or.knt.co.jp

Food / Beverage Tickets

Makuhari Subcenter Food / Beverage Tickets will be sold. Exhibitors who require Food / Beverage Tickets, are required to submit the “Application for Food / Beverage Tickets” to Makuhari Messe by Friday, October 23 or purchase on site.

■ About the Food and Beverage Tickets

1. These tickets are valid until Saturday, April 30, 2016.
2. Tickets are issued in ¥1,000 packets (three ¥250 tickets, two ¥100 tickets and one ¥50 ticket each).
3. They are redeemable at restaurants and cafeterias on the exhibition site, as well as at restaurants in Makuhari Messe, Hotel Green Tower Makuhari, Hotel Springs Makuhari, Hotel New Otani Makuhari, World Business Garden (WBG) , Makuhari Techno Garden (MTG) , Messe Amuse Mall, aune MAKUHARI, su:k Kaihin Makuhari, Hotel the Manhattan, Hotel Francs, APA Hotel & RESORT, Plena Makuhari, MITSUI OUTLET PARK MAKUHARI.

For more details, please see the website: (<http://www.m-messe.co.jp/en/newcityguide/index.html>)

■ How to Order

1. Purchasing in advance of the exhibition (Tickets will be mailed following bank transfer confirmation).
To purchase food and beverage tickets in advance, exhibitors should submit the Application. Tickets, a temporary receipt and a refund application form will be mailed following bank transfer confirmation. Applications will be invalid if transfers are not confirmed by November 5, after which tickets must be purchased on-site (cash only).
2. On-site (Cash only)
Food and beverage tickets can be purchased (cash only) from November 16 to November 20 at the following locations:
Makuhari Messe Inc. : International Conference Hall, 1F

■ Refund Policy

After the show, the full amount paid for on-site food and beverage tickets will be refundable if the exhibitor submits the temporary receipt, a refund application form and the unused tickets to Makuhari Messe Inc. within 2 weeks after the closing the show.

A receipt will be issued, and the total amount will be deposited into a bank account designated by the exhibitor. However, there are no refunds after the receipt issued.

Refunds cannot be made in cash.

Lunch box Delivery Service

Lunch box / beverage delivery service to your booth will be available during the exhibition period. Exhibitors who request delivery service, are required to submit the "Application for lunch box Delivery Service" to Wako Sangyo Co., Ltd. by November 13.

■ Delivery items

1. Daily lunch special

Choice of ¥780-lunch, ¥930-lunch, ¥1,130-lunch and ¥1,440-lunch

Note: Special party lunch plan will be available upon request.

2. Beverages

·Oolong tea (2L plastic bottle) : ¥500

·Oolong tea (500ml plastic bottle) : ¥160

·Mineral water (2L plastic bottle) : ¥450

·Japanese tea (500ml plastic bottle) : ¥160

·Beer (350ml can) : ¥400

·Paper cup (small) : ¥20

·Coffee maker set : ¥20,000

*This set includes coffee beans, paper cups, sugar, muddlers, milk and paper filters for 120 cups of coffee.

*Please prepare a socket (950w) inside your booth.

Above prices include 8% consumption tax.

■ Delivery time

Lunch / beverage will be delivered by 11:45 a.m. to your booth.

■ How to pay



Catering staff will visit your booth to collect the payment (in cash) in the afternoon of last day of exhibition.

If you wish to pay by bank transfer, please specify in the application.

Catering Service for Booths

In order to enhance services available for visitors, a catering service will be available at Inter BEE, providing snacks and beverages to booths when requested. If you wish to have catering delivered to your booth, fill in the Booth Catering Service Application and return the form to Nilax Corporation by Wednesday, Nov. 11. We hope that each exhibitor will make use of this service to facilitate successful business meetings and transactions with important clients and / or visitors.

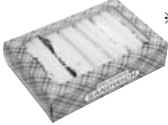
Menu

Menu	Serving style	Price (excluding consumption tax)
Coffee (10 cups per service)	Paper cup	¥180
	Ceramic cup	¥330
Iced coffee (10 cups per service)	Paper cup	¥180
	Ceramic cup	¥330
Tea (10 cups per service)	Paper cup	¥180
	Ceramic cup	¥330
Iced tea (10 cups per service)	Paper cup	¥180
	Ceramic cup	¥330
Oolong tea (10 cups per service)	Paper cup	¥180
	Ceramic cup	¥330
Orange juice (10 cups per service)	Paper cup	¥180
	Ceramic cup	¥330
Evian	330ml PET bottle	¥150
House wine (bottle and glasses)	Red	¥3,200
	White	¥3,200
Beer	Canned	¥450
Pastries (servings for 10)	 ※1	¥3,000
Sandwiches (boxed, single serving)	 ※1	¥500
Sandwiches platter (servings for 10)	 ※1	¥3,000
Assorted cookies		¥1,000

※1 Sample Image

※2 If you have any requests and inquiries, please contact following address.

Contact:

Nilax Ms. Kotani 2-1 Nakase Mihama-ku, Chiba-shi, Chiba 261-0023, Japan
TEL: +81-43-296-0512

Receptionist / Interpreter

If you require part-time staff to carry out reception duties etc. at your company booth, please fill in the required fields in the “Application Form for Reception Staff and Interpreters”, and send it to Ken & Staff Co., Ltd. by Friday, November 6.

■ Rates

Booth receptionist : ¥16,912 including tax (up to 8 hours per day)

Interpreter for Booth reception (English - Japanese) : ¥31,108 including tax (up to 8 hours per day)

Interpreter for Business meeting (English - Japanese) : ¥59,680 including tax (up to 8 hours per day)

■ Remarks

① The above amount is for up to 8 hours work, and for every one hour of overtime, we will charge one and one-quarter (1.25) times their regular pay of 1,650 yen (reception work), 3,300 yen (interpreting) and 6,600 yen (interpreting for business negotiations).

This also includes meal charges, traffic costs, and 8% consumption tax.

② We can provide a separate estimate relating to interpreting services for various foreign languages.

Booth Photography

Exhibitors who require booth photography, are requested to submit the Application for Booth Photography by Friday, November 6.

■ Service contents

1. Camera to be used
Digital camera (approximately 10 mega pixels)
2. Rate
¥10,800 (incl. consumption tax) per shot
Including one cabinet print.
Delivery fee will be charged separately.
3. Shooting date and time
According to your preference
4. Delivery
Photo data to be delivered on Friday, November 27.

Booth Cleaning

Exhibitors requiring booth-cleaning services must submit the Application for Booth cleaning to Chiba-Pref. Bldg. maintenance corp. by Friday, November 6.

(1) Cleaning Charge

¥1,944 (tax included) per booth (9 m²) Specify the number of booths to be cleaned when in the application form.

(2) Period available

Daily after 5:30 p.m. from November 17 to November 19.

(3) Cleaning method

Vacuuming or mopping the booth floor (cleaning of display counters, showcases and products not included)